

SPÉCIFICATION TECHNIQUES

| | |
|-----------------------------------------|--------------|
| Puissance | jusqu'à 4 kW |
| Temps de combustion | 4,5 heures |
| Volume du récipient | 3 litres |
| Combustible | bioéthanol |
| Poids de l'insert à gaz | 62 kg |
| Poids de l'insert à gaz avec revêtement | 82 kg |

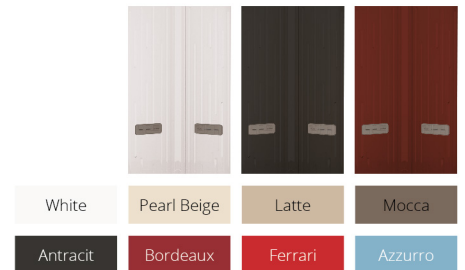

DESSIN TECHNIQUE

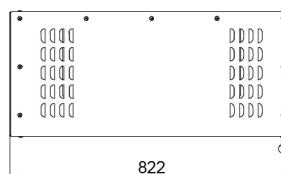
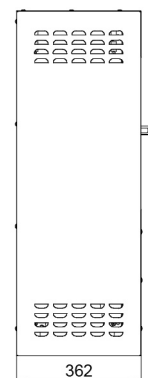
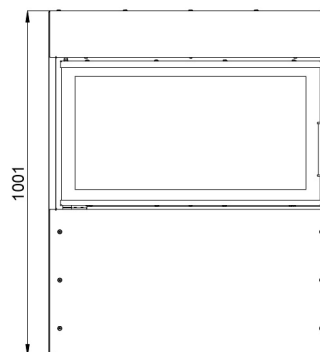
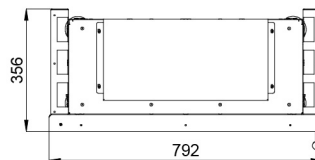
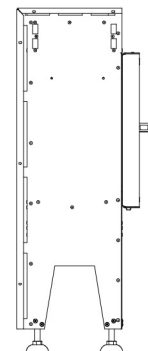
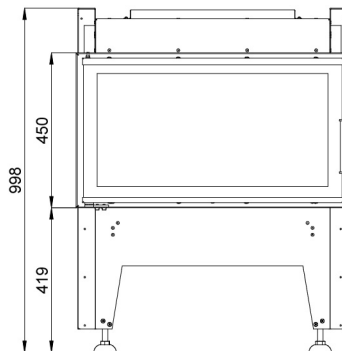

BEF SPIRIT 8

ČSN EN
13229